



AiP74LVC2G04 Dual Inverter

Product Specification

Specification Revision History:

Version	Date	Description
2017-07-A1	2017-07	New
2023-04-B1	2023-04	Update the template



Contents

1、 General Description.....	3
2、 Block Diagram And Pin Description	4
2.1、 Block Diagram	4
2.2、 Pin Configurations.....	4
2.3、 Pin Description	4
2.4、 Function Table.....	5
3、 Electrical Parameter	5
3.1、 Absolute Maximum Ratings.....	5
3.2、 Recommended Operating Conditions	5
3.3、 Electrical Characteristics	6
3.3.1、 DC Characteristics 1	6
3.3.2、 DC Characteristics 2	7
3.3.3、 AC Characteristics 1	8
3.3.4、 AC Characteristics 2	8
4、 Testing Circuit	9
4.1、 AC Testing Circuit	9
4.2、 AC Testing Waveforms.....	9
4.3、 Measurement Points	9
4.4、 Test Data	9
5、 Package Information	10
5.1、 SOT-23-6.....	10
5.2、 SOT-363.....	11
6、 Statements And Notes	12
6.1、 The name and content of Hazardous substances or Elements in the product.....	12
6.2、 Notes	12



1、 General Description

The AiP74LVC2G04 provides the dual inverting buffer.

Inputs can be driven from either 3.3V or 5V devices. These features allow the use of these devices in a mixed 3.3V and 5V environment.

Features:

- Wide supply voltage range from 1.65V to 5.5V
- 5V tolerant inputs for interfacing with 5V logic
- $\pm 24\text{mA}$ output drive ($V_{CC}=3.0\text{V}$)
- CMOS low power consumption
- Specified from -40°C to $+125^{\circ}\text{C}$
- Packaging information: SOT-23-6/SOT-363

Ordering Information:

Reel packing specifications:

Part number	Packaging form	Marking code	Reel quantity	Boxed reel quantity	Notes
AiP74LVC2G04GB236.TR	SOT-23-6	AMXX	3000 PCS/reel	30000 PCS/box	Dimensions of plastic enclosure: 2.9mm×1.6mm Pin spacing: 0.95mm
AiP74LVC2G04GC363.TR	SOT-363	AMXX	3000 PCS/reel	30000 PCS/box	Dimensions of plastic enclosure: 2.1mm×1.3mm Pin spacing: 0.65mm

Note 1: "XX" refers to variable content, meaning year and package batch serial number.

Note 2: If the physical information is inconsistent with the ordering information, please refer to the actual product.



2、Block Diagram And Pin Description

2.1、Block Diagram

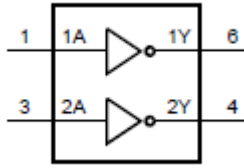

Figure 1. Logic symbol

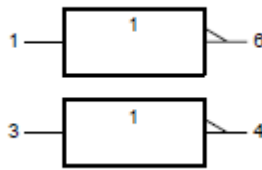

Figure 2. IEC logic symbol

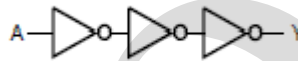
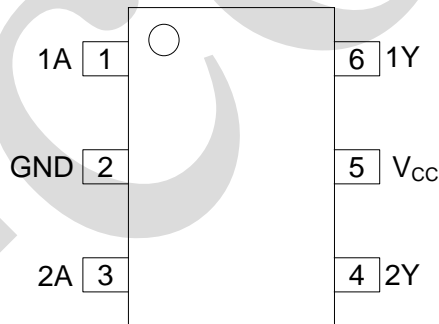

Figure 3. Logic diagram (one gate)

2.2、Pin Configurations



2.3、Pin Description

Pin No.	Pin Name	Description
1	1A	data input
2	GND	ground (0V)
3	2A	data input
4	2Y	data output
5	V _{CC}	supply voltage
6	1Y	data output



2.4、Function Table

Input	Output
nA	nY
L	H
H	L

Note: H=HIGH voltage level; L=LOW voltage level.

3、Electrical Parameter

3.1、Absolute Maximum Ratings

(Voltages are referenced to GND(ground=0V), unless otherwise specified.)

Parameter	Symbol	Conditions	Min.	Max.	Unit
supply voltage	V_{CC}	-	-0.5	+6.5	V
input clamping current	I_{IK}	$V_I < 0V$	-50	-	mA
input voltage	V_I	-	-0.5	+6.5	V
output clamping current	I_{OK}	$V_O > V_{CC}$ or $V_O < 0V$	-	± 50	mA
output voltage	V_O	Active mode	-0.5	$V_{CC}+0.5$	V
		Power-down mode	-0.5	+6.5	V
output current	I_O	$V_O=0V$ to V_{CC}	-	± 50	mA
supply current	I_{CC}	-	-	100	mA
ground current	I_{GND}	-	-100	-	mA
total power dissipation	P_{tot}	-	-	250	mW
storage temperature	T_{stg}	-	-65	+150	°C
soldering temperature	T_L	10s	260		°C

Note: When $V_{CC}=0V$ (Power-down mode), the output voltage can be 5.5V in normal operation.

3.2、Recommended Operating Conditions

Parameter	Symbol	Conditions	Min.	Typ.	Max.	Unit
supply voltage	V_{CC}	-	1.65	-	5.5	V
input voltage	V_I	-	0	-	5.5	V
output voltage	V_O	Active mode	0	-	V_{CC}	V
		Power-down mode; $V_{CC}=0V$	0	-	5.5	V
ambient temperature	T_{amb}	-	-40	-	+125	°C



3.3、Electrical Characteristics

3.3.1、DC Characteristics 1

($T_{amb} = -40^{\circ}\text{C}$ to $+85^{\circ}\text{C}$, voltages are referenced to GND (ground=0V), unless otherwise specified.)

Parameter	Symbol	Conditions	Min.	Typ.	Max.	Unit	
HIGH-level input voltage	V_{IH}	$V_{CC}=1.65\text{V}$ to 1.95V	$0.65 \times V_{CC}$	-	-	V	
		$V_{CC}=2.3\text{V}$ to 2.7V	1.7	-	-	V	
		$V_{CC}=2.7\text{V}$ to 3.6V	2.0	-	-	V	
		$V_{CC}=4.5\text{V}$ to 5.5V	$0.7 \times V_{CC}$	-	-	V	
LOW-level input voltage	V_{IL}	$V_{CC}=1.65\text{V}$ to 1.95V	-	-	$0.35 \times V_{CC}$	V	
		$V_{CC}=2.3\text{V}$ to 2.7V	-	-	0.7	V	
		$V_{CC}=2.7\text{V}$ to 3.6V	-	-	0.8	V	
		$V_{CC}=4.5\text{V}$ to 5.5V	-	-	$0.3 \times V_{CC}$	V	
HIGH-level output voltage	V_{OH}	$V_I = V_{IH}$ or V_{IL}	$I_O = -100\mu\text{A}$; $V_{CC}=1.65\text{V}$ to 5.5V	$V_{CC} - 0.1$	-	-	V
			$I_O = -4\text{mA}$; $V_{CC}=1.65\text{V}$	1.2	-	-	V
			$I_O = -8\text{mA}$; $V_{CC}=2.3\text{V}$	1.9	-	-	V
			$I_O = -12\text{mA}$; $V_{CC}=2.7\text{V}$	2.2	-	-	V
			$I_O = -24\text{mA}$; $V_{CC}=3.0\text{V}$	2.3	-	-	V
			$I_O = -32\text{mA}$; $V_{CC}=4.5\text{V}$	3.8	-	-	V
LOW-level output voltage	V_{OL}	$V_I = V_{IH}$ or V_{IL}	$I_O = 100\mu\text{A}$; $V_{CC}=1.65\text{V}$ to 5.5V	-	-	0.10	V
			$I_O = 4\text{mA}$; $V_{CC}=1.65\text{V}$	-	-	0.45	V
			$I_O = 8\text{mA}$; $V_{CC}=2.3\text{V}$	-	-	0.30	V
			$I_O = 12\text{mA}$; $V_{CC}=2.7\text{V}$	-	-	0.40	V
			$I_O = 24\text{mA}$; $V_{CC}=3.0\text{V}$	-	-	0.55	V
			$I_O = 32\text{mA}$; $V_{CC}=4.5\text{V}$	-	-	0.55	V
input leakage current	I_I	$V_I = 5.5\text{V}$ or GND; $V_{CC} = 0\text{V}$ to 5.5V	-	-	± 1	μA	
power-off leakage current	I_{OFF}	V_I or $V_O = 5.5\text{V}$; $V_{CC} = 0\text{V}$	-	-	± 2	μA	
supply current	I_{CC}	$V_I = 5.5\text{V}$ or GND; $I_O = 0\text{A}$; $V_{CC} = 1.65\text{V}$ to 5.5V	-	-	4	μA	
additional supply current	ΔI_{CC}	per pin; $V_I = V_{CC} - 0.6\text{V}$; $I_O = 0\text{A}$; $V_{CC} = 2.3\text{V}$ to 5.5V	-	-	500	μA	
input capacitance	C_I	$V_{CC} = 3.3\text{V}$; $V_I = \text{GND}$ to V_{CC}	-	2.5	-	pF	

Note: All typical values are measured at $T_{amb} = 25^{\circ}\text{C}$.



3.3.2、DC Characteristics 2

($T_{amb} = -40^{\circ}\text{C}$ to $+125^{\circ}\text{C}$, voltages are referenced to GND (ground=0V), unless otherwise specified.)

Parameter	Symbol	Conditions	Min.	Typ.	Max.	Unit	
HIGH-level input voltage	V_{IH}	$V_{CC}=1.65\text{V}$ to 1.95V	$0.65 \times V_{CC}$	-	-	V	
		$V_{CC}=2.3\text{V}$ to 2.7V	1.7	-	-	V	
		$V_{CC}=2.7\text{V}$ to 3.6V	2.0	-	-	V	
		$V_{CC}=4.5\text{V}$ to 5.5V	$0.7 \times V_{CC}$	-	-	V	
LOW-level input voltage	V_{IL}	$V_{CC}=1.65\text{V}$ to 1.95V	-	-	$0.35 \times V_{CC}$	V	
		$V_{CC}=2.3\text{V}$ to 2.7V	-	-	0.7	V	
		$V_{CC}=2.7\text{V}$ to 3.6V	-	-	0.8	V	
		$V_{CC}=4.5\text{V}$ to 5.5V	-	-	$0.3 \times V_{CC}$	V	
HIGH-level output voltage	V_{OH}	$V_I = V_{IH}$ or V_{IL}	$I_O = -100\mu\text{A}; V_{CC}=1.65\text{V}$ to 5.5V	$V_{CC} - 0.1$	-	-	V
			$I_O = -4\text{mA}; V_{CC}=1.65\text{V}$	0.95	-	-	V
			$I_O = -8\text{mA}; V_{CC}=2.3\text{V}$	1.7	-	-	V
			$I_O = -12\text{mA}; V_{CC}=2.7\text{V}$	1.9	-	-	V
			$I_O = -24\text{mA}; V_{CC}=3.0\text{V}$	2.0	-	-	V
			$I_O = -32\text{mA}; V_{CC}=4.5\text{V}$	3.4	-	-	V
LOW-level output voltage	V_{OL}	$V_I = V_{IH}$ or V_{IL}	$I_O = 100\mu\text{A}; V_{CC}=1.65\text{V}$ to 5.5V	-	-	0.10	V
			$I_O = 4\text{mA}; V_{CC}=1.65\text{V}$	-	-	0.70	V
			$I_O = 8\text{mA}; V_{CC}=2.3\text{V}$	-	-	0.45	V
			$I_O = 12\text{mA}; V_{CC}=2.7\text{V}$	-	-	0.60	V
			$I_O = 24\text{mA}; V_{CC}=3.0\text{V}$	-	-	0.80	V
			$I_O = 32\text{mA}; V_{CC}=4.5\text{V}$	-	-	0.80	V
input leakage current	I_I	$V_I = 5.5\text{V}$ or GND; $V_{CC} = 0\text{V}$ to 5.5V	-	-	± 1	μA	
power-off leakage current	I_{OFF}	V_I or $V_O = 5.5\text{V}; V_{CC} = 0\text{V}$	-	-	± 2	μA	
supply current	I_{CC}	$V_I = 5.5\text{V}$ or GND; $I_O = 0\text{A}; V_{CC} = 1.65\text{V}$ to 5.5V	-	-	4	μA	
additional supply current	ΔI_{CC}	per pin; $V_I = V_{CC} - 0.6\text{V}; I_O = 0\text{A}; V_{CC} = 2.3\text{V}$ to 5.5V	-	-	500	μA	



3.3.3、AC Characteristics 1

($T_{amb}=-40^{\circ}\text{C}$ to $+85^{\circ}\text{C}$, voltages are referenced to GND (ground=0V), unless otherwise specified.)

Parameter	Symbol	Conditions	Min.	Typ. ^[1]	Max.	Unit	
nA to nY propagation delay	t_{PHL}	see Figure 5	$V_{CC}=1.65\text{V}$ to 1.95V	-	12.5	18.8	ns
			$V_{CC}=2.3\text{V}$ to 2.7V	-	10.5	15.8	ns
			$V_{CC}=2.7\text{V}$	-	10	15	ns
			$V_{CC}=3.0\text{V}$ to 3.6V	-	9.5	14.3	ns
			$V_{CC}=4.5\text{V}$ to 5.5V	-	9	13.5	ns
nA to nY propagation delay	t_{PLH}	see Figure 5	$V_{CC}=1.65\text{V}$ to 1.95V	-	14	21	ns
			$V_{CC}=2.3\text{V}$ to 2.7V	-	10	15	ns
			$V_{CC}=2.7\text{V}$	-	9.5	14.3	ns
			$V_{CC}=3.0\text{V}$ to 3.6V	-	8.5	12.8	ns
			$V_{CC}=4.5\text{V}$ to 5.5V	-	7.5	11.3	ns

Note:

[1] Typical values are measured at $T_{amb}=25^{\circ}\text{C}$ and $V_{CC}=1.8\text{V}$, 2.5V , 2.7V , 3.3V and 5.0V respectively.

3.3.4、AC Characteristics 2

($T_{amb}=-40^{\circ}\text{C}$ to $+125^{\circ}\text{C}$, voltages are referenced to GND (ground=0V), unless otherwise specified.)

Parameter	Symbol	Conditions	Min.	Typ.	Max.	Unit	
nA to nY propagation delay	t_{PHL}	I0, I1 to Y; see Figure 5	$V_{CC}=1.65\text{V}$ to 1.95V	-	-	20.8	ns
			$V_{CC}=2.3\text{V}$ to 2.7V	-	-	17.8	ns
			$V_{CC}=2.7\text{V}$	-	-	17	ns
			$V_{CC}=3.0\text{V}$ to 3.6V	-	-	16.3	ns
			$V_{CC}=4.5\text{V}$ to 5.5V	-	-	15.5	ns
nA to nY propagation delay	t_{PLH}	I0, I1 to Y; see Figure 5	$V_{CC}=1.65\text{V}$ to 1.95V	-	-	23	ns
			$V_{CC}=2.3\text{V}$ to 2.7V	-	-	17	ns
			$V_{CC}=2.7\text{V}$	-	-	16.3	ns
			$V_{CC}=3.0\text{V}$ to 3.6V	-	-	14.8	ns
			$V_{CC}=4.5\text{V}$ to 5.5V	-	-	13.3	ns



4、Testing Circuit

4.1、AC Testing Circuit

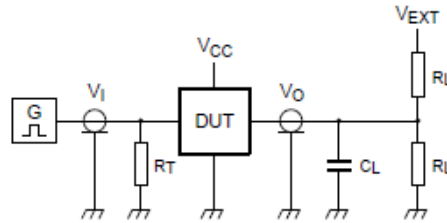

Figure 4. Test circuit for measuring switching times

Definitions for test circuit:

R_L =Load resistance.

C_L =Load capacitance including jig and probe capacitance.

R_T =Termination resistance; should be equal to the output impedance Z_o of the pulse generator.

V_{EXT} =External voltage for measuring switching times.

4.2、AC Testing Waveforms

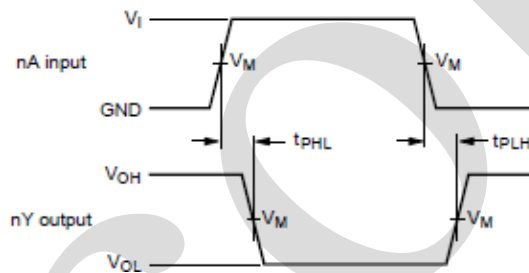

Figure 5. The input nA to output nY propagation delays

4.3、Measurement Points

Supply voltage	Input	Output
V_{CC}	V_M	V_M
1.65V to 1.95V	$0.5 \times V_{CC}$	$0.5 \times V_{CC}$
2.3V to 2.7V	$0.5 \times V_{CC}$	$0.5 \times V_{CC}$
2.7V	1.5V	1.5V
3.0V to 3.6V	1.5V	1.5V
4.5V to 5.5V	$0.5 \times V_{CC}$	$0.5 \times V_{CC}$

4.4、Test Data

Supply voltage	Input		Load		V_{EXT}
	V_I	$t_r = t_f$	C_L	R_L	t_{PLH}, t_{PHL}
1.65V to 1.95V	V_{CC}	$\leq 3ns$	30pF	1k Ω	open
2.3V to 2.7V	V_{CC}	$\leq 3ns$	30pF	500 Ω	open
2.7V	2.7V	$\leq 3ns$	50pF	500 Ω	open
3.0V to 3.6V	2.7V	$\leq 3ns$	50pF	500 Ω	open
4.5V to 5.5V	V_{CC}	$\leq 3ns$	50pF	500 Ω	open



5、Package Information

5.1、SOT-23-6

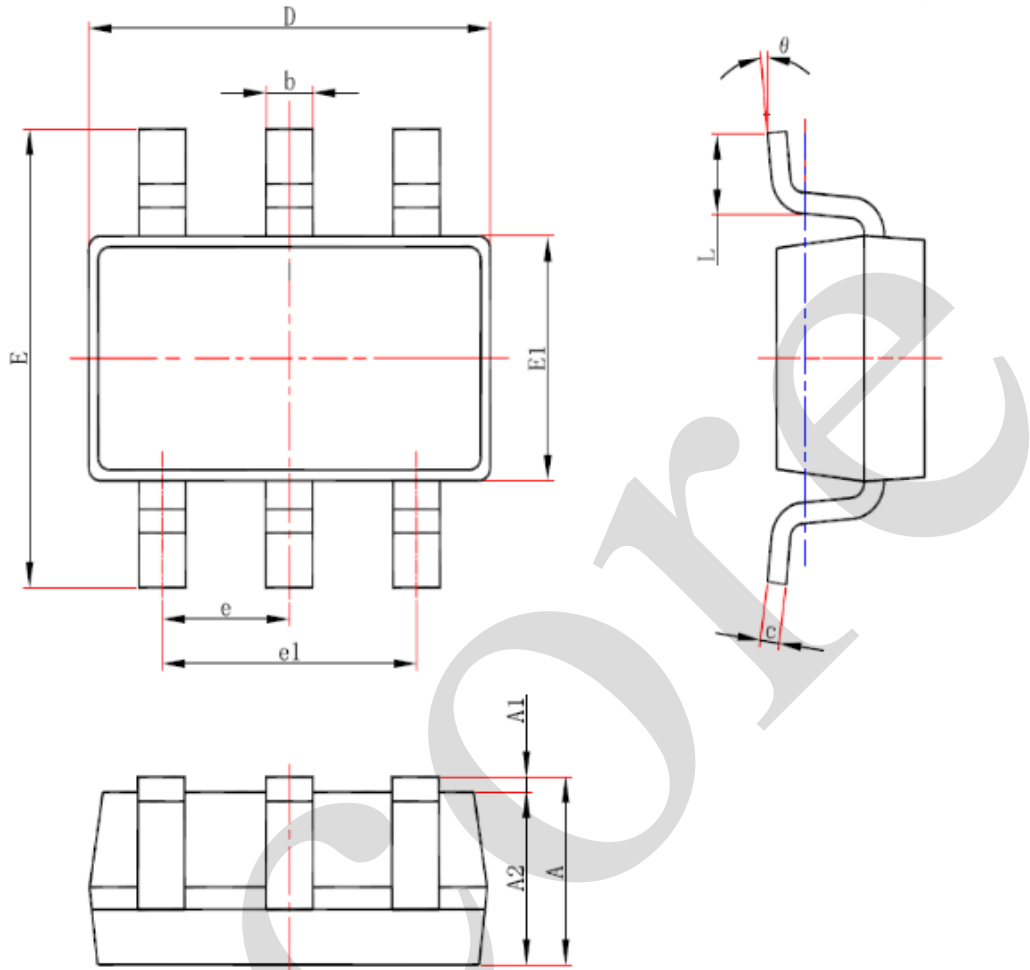

Symbol	Dimensions (mm)	
	Min.	Max.
A	-	1.25
A1	0.00	0.12
A2	1.00	1.20
b	0.30	0.50
c	0.10	0.20
D	2.82	3.02
E	2.60	3.00
E1	1.50	1.70
e	0.95	
e1	1.80	2.00
L	0.30	0.60
θ	0°	8°



5.2、SOT-363

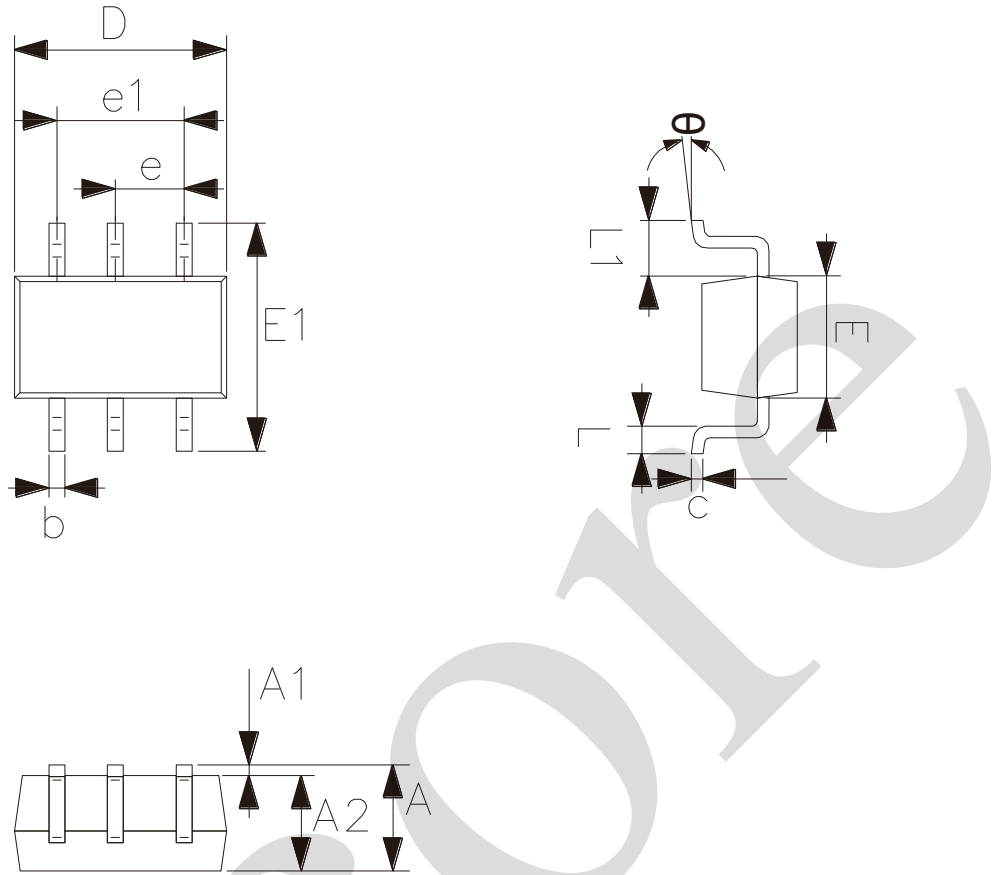

Symbol	Dimensions (mm)	
	Min.	Max.
A	0.90	1.10
A1	0.00	0.10
A2	0.90	1.00
b	0.15	0.35
c	0.11	0.175
D	2.00	2.20
E1	2.15	2.45
E	1.15	1.35
e	0.65	
e1	1.20	1.40
L	0.26	0.46
L1	0.525	
θ	0°	8°



6、 Statements And Notes

6.1、 The name and content of Hazardous substances or Elements in the product

Part name	Hazardous substances or Elements									
	Lead and lead compounds	Mercury and mercury compounds	Cadmium and cadmium compounds	Hexavalent chromium compounds	Polybrominated biphenyls	Polybrominated biphenyl ethers	Dibutyl phthalate	Butylbenzyl phthalate	Di-2-ethylhexyl phthalate	Diisobutyl phthalate
Lead frame	○	○	○	○	○	○	○	○	○	○
Plastic resin	○	○	○	○	○	○	○	○	○	○
Chip	○	○	○	○	○	○	○	○	○	○
The lead	○	○	○	○	○	○	○	○	○	○
Plastic sheet installed	○	○	○	○	○	○	○	○	○	○
explanation	○: Indicates that the content of hazardous substances or elements in the detection limit of the following the SJ/T11363-2006 standard. ×: Indicates that the content of hazardous substances or elements exceeding the SJ/T11363-2006 Standard limit requirements.									

6.2、 Notes

We Recommend you to read this chapter carefully before using this product.

The information in this chapter is provided for reference only and i-Core disclaims any express or implied warranties, including but not limited to applicability, special application or non-infringement of third party rights.

This product is not suitable for critical equipment such as life-saving, life-sustaining or safety equipment. It is also not suitable for applications that may result in personal injury, death, or serious property or environmental damage due to product malfunction or failure. I-Core will not be liable for any damages incurred by the customers at their own risk for such applications.

The customer is responsible for conducting all necessary tests i-Core's application to avoid failure in the application or the application of the customer's third party users. I-Core does not accept any liability.

The Company reserves the right to change or improve the information published in this chapter at any time. The information in this chapter are subject to change without notice. We recommend the customer to consult our sales staff before purchasing.

Please obtain related materials form i-Core's regular channels and we are not responsible for its content if it is provided by sources other than our company.

In case of any conflict between the Chinese and English version, the version is subject to the Chinese one.